

INDOOR HOT TUBS SQUARO EDGE 12

PRODUCT INFORMATION

1. POSITION



Article number	UAE160SQE2B2V01
Article title	Villeroy & Boch Squaro Edge 12 Rectangular bath, with whirlpool system Airpool Entry (AE), included Water inlet, 1600 x 750 mm, White Alpin
Product designation	Airpool Entry (AE)
Collection	Squaro Edge 12
Assembly / Assembly type	built-in installation
Scope of delivery	1 x bath incl. whirlpool system , 1 x Multiplex Trio
Length in mm	1600
Width in mm	750
Height in mm	475
Installation height	<ul style="list-style-type: none"> • Whirlpool system: 620 - 660 mm • Profibox 2.0 incl. System: 625 - 625 mm
Interior depth	450
Weight in kg	58,80
Outlet / outlet	central outlet
Function	<ul style="list-style-type: none"> • with lighting • with blow-dry feature • with rim-mounted control
Material	Quaryl®
Colour name	White Alpin
With feet/base	Yes
With panel	No
Other material	<ul style="list-style-type: none"> • Waste/overflow combination: Plastic • Plastic Outlet cover: Plastic • Plastic
Other surfaces	Waste/overflow combination: glossy, glossy, Outlet cover: glossy glossy
With bath support	No
Operating mode	Mains-operated
Energy detection	, This light contains built-in LEDs. The LEDs in the light cannot be replaced.
Lighting	2x LED
Power of lamp	2 x LED / 1.6 W

Light colour (designation & colour temperature)	~ 4400 K (neutral white)
Degree of protection	IP X5
Water content	235
Capacity incl. 1 pers	160
Number of people	2
For handle mounting	Yes
Outlet/overflow set	Multiplex Trio
Seat unit	2
Information on technical position	Technical parts 2
Technical position	Technical parts 2
EAN number	4051202405953
Number of jets in the base	10

COLOUR

COLOUR DESIGNATION



White Alpin

TECHNICAL DRAWINGS

UAE160SQE2B2V01

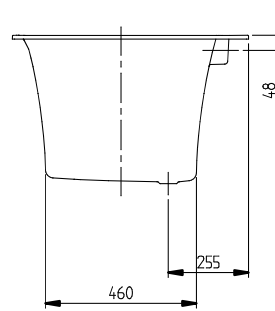
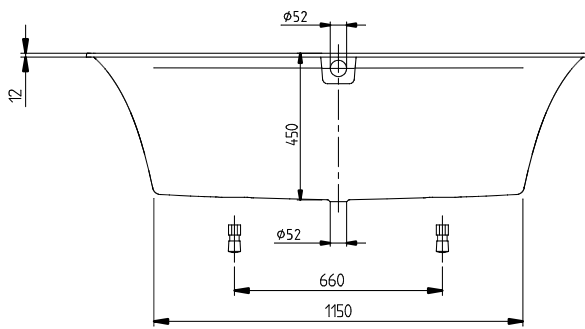
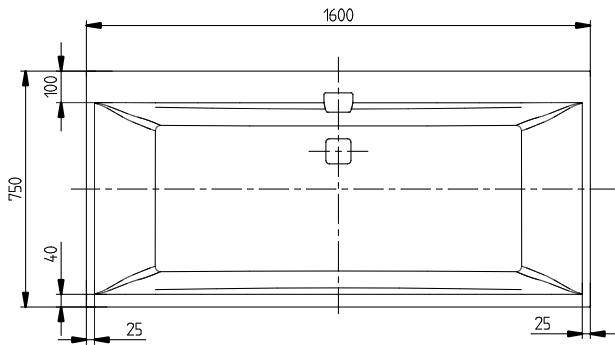

<p>SQUARO EDGE 1 2 1600x750 UBQ160SQE2 V02/ 20-04-2020</p>	 <p>Villeroy & Boch 1748</p>
--	--