

WASHBASINS COLLARO

PRODUCT INFORMATION

1. POSITION



Article number	4A2056R1
Article title	Villeroy & Boch Collaro Surface-mounted washbasin, 560 x 360 x 145 mm, without overflow, White Alpin CeramicPlus
Product designation	Surface-mounted washbasin
Collection	Collaro
Assembly / Assembly type	Surface-mounted
Assembly instructions	Recommendation: to be installed with a gap of at least 50 mm between the washbasin and the wall
Scope of delivery	1 x surface-mounted washbasin , 1 x fastening set 1 x cut-out template
Ordering information	Please order non-closable drain valve separately.
Length in mm	360
Width in mm	560
Height in mm	145
Interior depth	100
Weight in kg	14,37
express delivery	No
Suitable for	Wall-mounted tap fittings, Matching Villeroy&Boch furniture Tap fitting with raised base
Material	TitanCeram
Surface	glossy
Colour name	White Alpin CeramicPlus
With TitanGlaze	No
With overflow	No
EAN number	4051202728656

COLOUR

COLOUR DESIGNATION



White Alpin

TECHNICAL DRAWINGS

4A2056R1

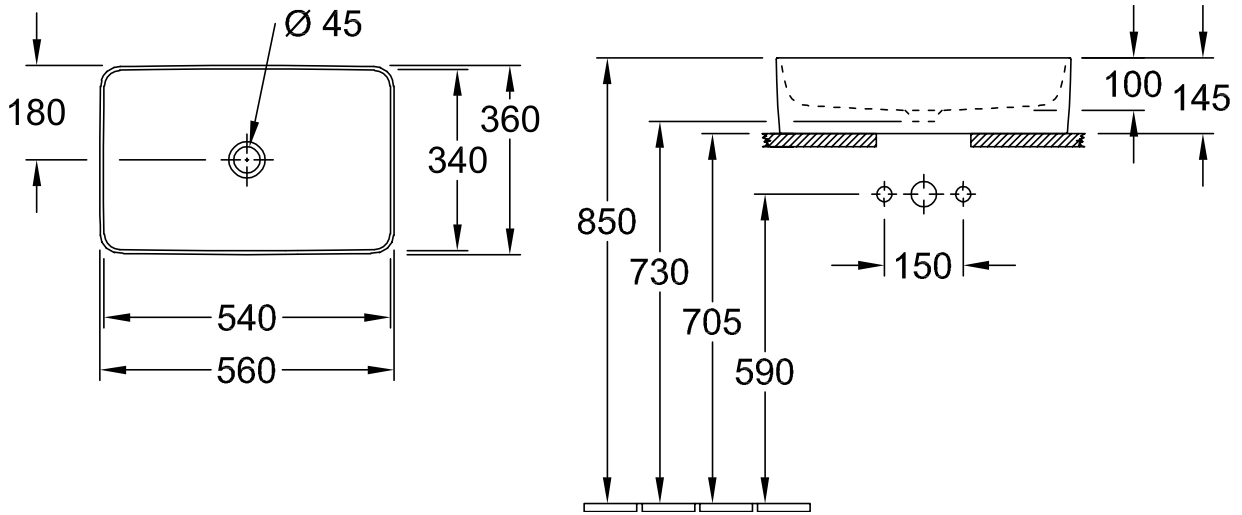

EXPLOSION DRAWINGS

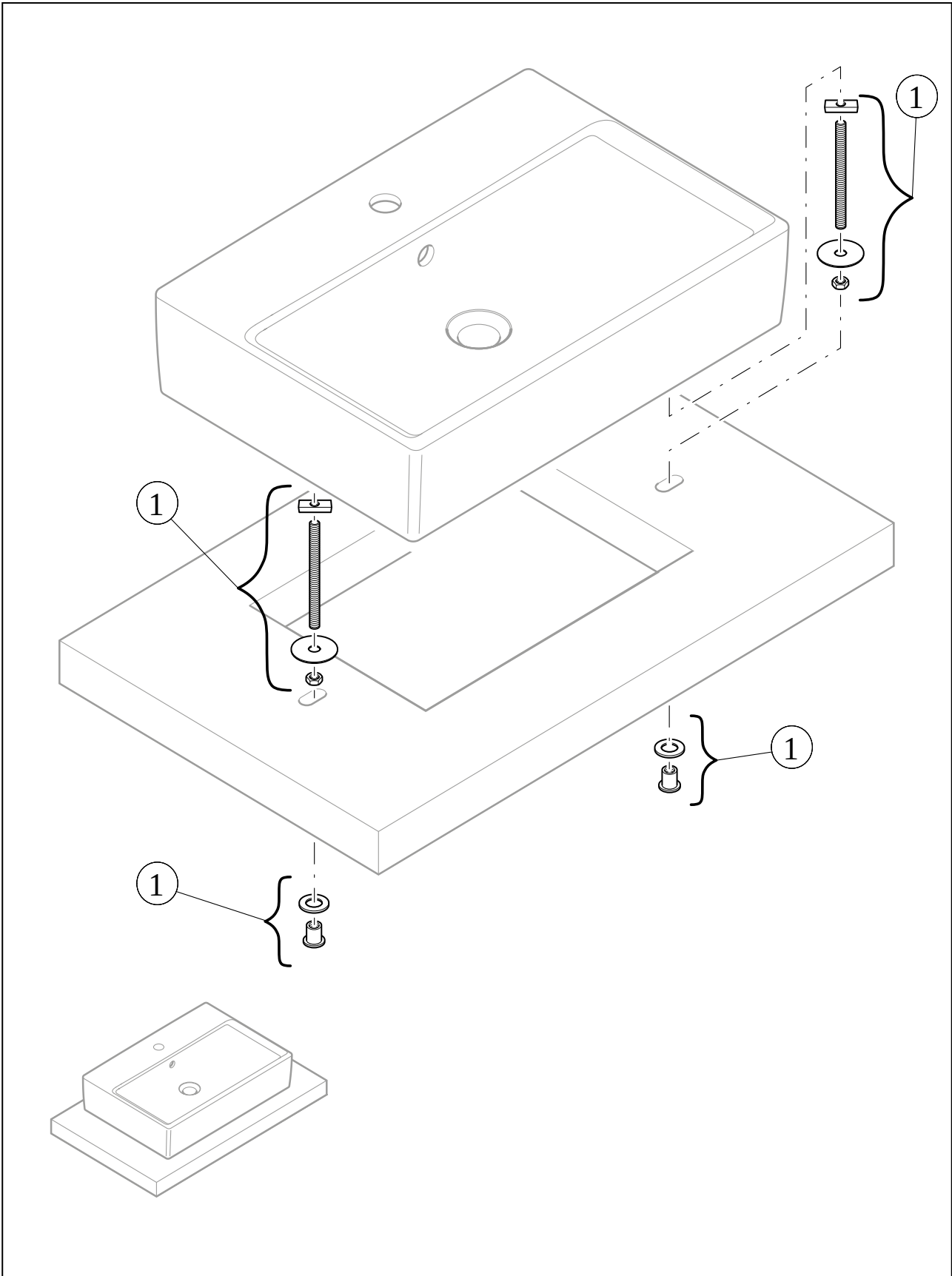

BILL OF MATERIALS

No.	Article No.	Description	Quantity
1	92225600	Fastening set	1