

WASHBASINS MEMENTO 2.0

PRODUCT INFORMATION

1. POSITION



Article number	4A076001
Article title	Villeroy & Boch Memento 2.0 Surface-mounted washbasin, 600 x 420 x 140 mm, with overflow, White Alpin
Product designation	Surface-mounted washbasin
Collection	Memento 2.0
Assembly / Assembly type	Surface-mounted
Assembly instructions	Recommendation: to be installed with a gap of at least 50 mm between the washbasin and the wall
Scope of delivery	1 x surface-mounted washbasin , 1 x fastening set 1 x cut-out template
Ordering information	Optionally available: Outlet valve with ceramic cover.
Length in mm	420
Width in mm	600
Height in mm	140
Interior depth	90
Weight in kg	17,60
Number of tap holes punched through	1
Number of tap holes pre-drilled	2
Position of drill hole	central tap hole punched out
express delivery	No
Suitable for	3-hole mixer, Matching Villeroy&Boch furniture
Material	TitanCeram
Surface	glossy
Colour name	White Alpin
With TitanGlaze	No
With overflow	Yes
EAN number	4051202567293

COLOUR

COLOUR DESIGNATION



White Alpin

TECHNICAL DRAWINGS

4A076001

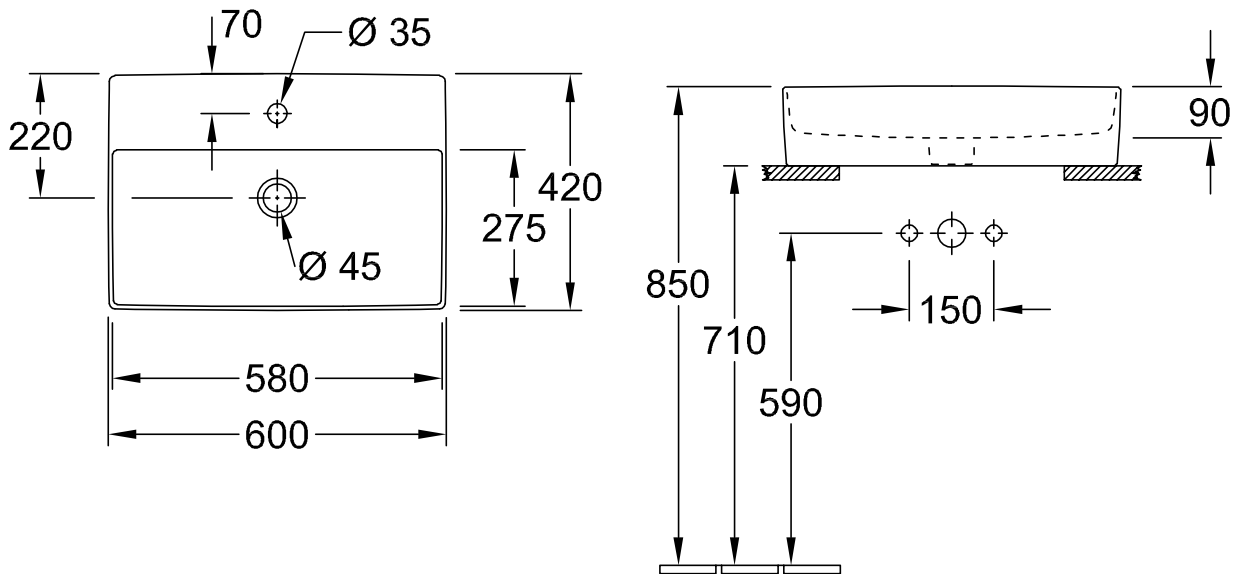

EXPLOSION DRAWINGS

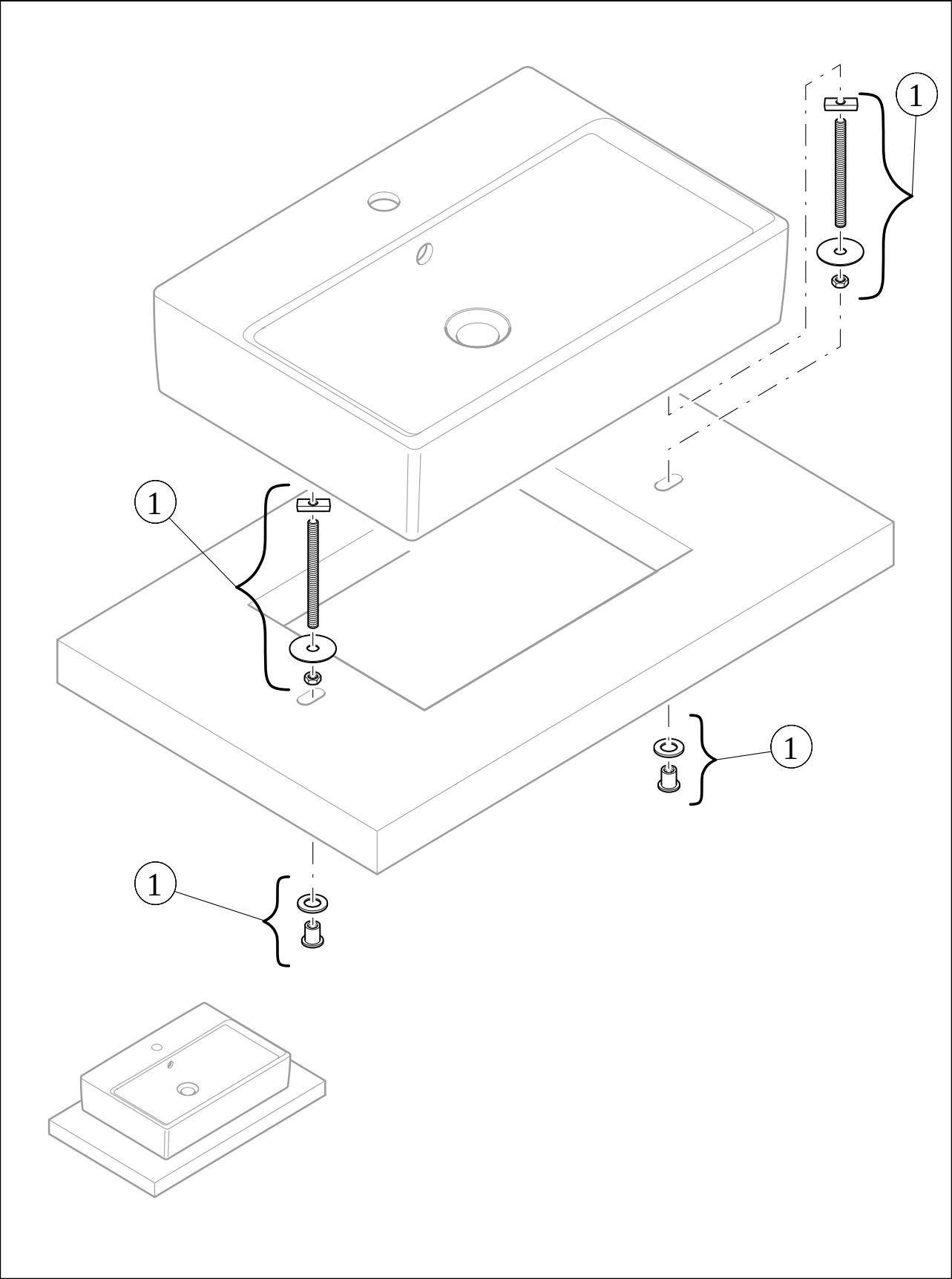

BILL OF MATERIALS

No.	Article No.	Description	Quantity
1	92225600	Fastening set	1